

## DIABON® Rupture disks

Rupture disks are used to assure high safety standards for operators and equipment in plants by avoiding uncontrolled pressure built-ups. Processing of highly corrosive media requires the use of corrosion resistant rupture disks.

SGL Carbon's rupture disks are made exclusively from (DIABON) graphite, PFA (fluoroplastic), PTFE and SIGRAFLEX® graphite foil. These materials are notable for their high resistance to a large number of aggressive media.

They are characterized by a precise threshold pattern with a large opening of the full cross section in case of activation.

While in metal safety disks the bursting pressure is a function of the operating temperature, we provide DIABON safety disks where this is only true at temperatures above 50 °C [Series N, D and DV], 250 °C [Series F] or even 300 °C [Series HT].

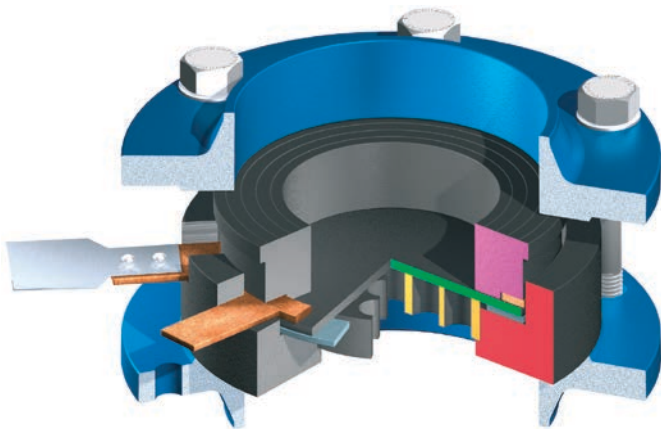

↑ Example setup of DIABON series D safety disk



↑ DIABON safety disks

### Customer benefits

- **Safety:** large range of rupture disk design and material options available for multiple process conditions; alarm system can be provided
- **Performance:** brittle material behavior results in opening of the full cross section
- **Service excellence:** fast and competent services for repair and spare parts

By the way: DIABON phenolic resin impregnated graphite is certified by FDA (Food and Drug Administration)

## Our solutions for typical applications





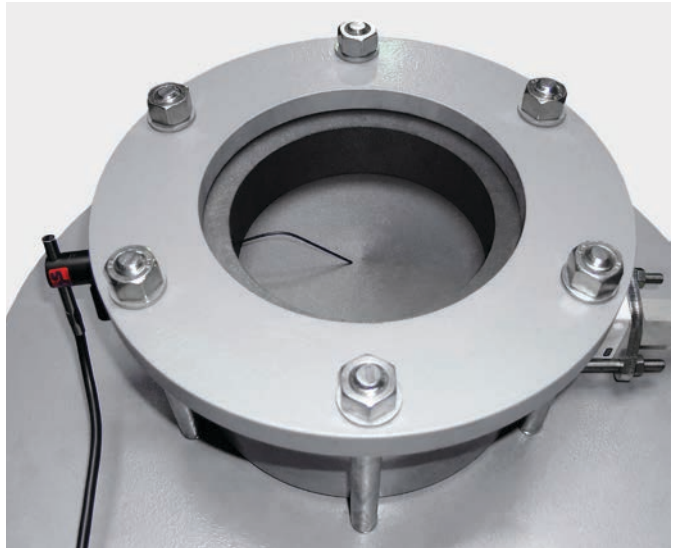

Several variants of bursting disks are available to serve your special purposes.

- Series N with resin impregnation for universal use in standard applications
- Series F with PFA coating for high temperature, vacuum and food applications
- Series HT for highest temperatures (up to 300 °C)
- Series D with a three-part construction for repeated reuse of holder and lowest costs
- Series DV with a three-part construction and a self-supporting holder for repeated reuse of holder, ease of assembly (insensitive to torque) and low costs
- Bursting-type safety devices made from SIGRAFLEX graphite foil for very low pressures
- Also available are corrosion resistant alarm systems for rupture disks

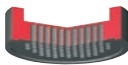

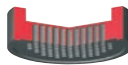
↑ Rupture disk with alarm system

## Data for DIABON® safety disks

Technical specifications	Units	Series						
		F	NI	NII	HTI	HTII	D	DV
Design								
Type of design		monoblock	monoblock	monoblock	monoblock	monoblock	three-part	three-part
Bursting pressure	barg	0.20 – 35	0.10 – 50	2.00 – 80	0.10 – 35	1.00 – 80	0.34 – 30	0.07 – 10
Temperature range	°C	-60 to +250	-60 to +180	-60 to +180	-60 to +300	-60 to +300	-60 to +180	-60 to +180
Bursting tolerance	%	+/- 10	+/- 10	+/- 10	+/- 10	+/- 10	+/- 10	+/- 5
Vacuum suited		•	•		•		•	•
Bursting behavior unaffected by temperature		•			•	•		
FDA approved		•			•	•		
Sealing		SIGRAFLEX/ PFA	SIGRAFLEX/ resin impregnation	SIGRAFLEX/ resin impregnation	SIGRAFLEX/ SIGRAFLEX or PTFE	SIGRAFLEX/ SIGRAFLEX or PTFE	SIGRAFLEX/ resin impregnation	SIGRAFLEX/ resin impregnation
Mounting		DIN/ANSI	DIN/ANSI	DIN/ANSI	DIN/ANSI	DIN/ANSI	DIN/ANSI	DIN/ANSI



**Graphite Materials & Systems | SGL CARBON GmbH**  
 Sales Europe/Middle East/Africa | pt-europe@sglcarbon.com  
 Sales Americas | pt-americas@sglcarbon.com  
 Sales Asia/Pacific | pt-asia@sglcarbon.com  
 www.sglcarbon.com

### TIS Rupture disks.00

05 2018/0.25 E Printed in Germany

®registered trademarks of SGL Carbon SE

The data contained herein represent the current state of our product knowledge and are intended to provide general information on our products and their application spectra. In view of the variety and large number of application possibilities, these data should be regarded merely as general information that gives no guarantee of any specific properties and/or suitability of those products for any particular application. Consequently, when ordering a product, please contact us for specific information on the properties required for the application concerned. On request, our technical service will supply a profile of characteristics for your specific application requirements without delay.